

ENFORCER®

Outdoor Wave-to-Open Sensors

Manual



Language	Slimline Plate	Single-Gang Plate	European Plate
English	SD-9163-KSQ*	SD-9263-KSQ*	SD-9363-KSQ*
Spanish	SD-9163-KS1Q*	SD-9263-KS1Q*	SD-9363-KS1Q*
French	SD-9163-KS2Q*	SD-9263-KS2Q*	SD-9363-KS2Q*
English w/ mechanical override button	SD-9163-KSVQ	SD-9263-KSVQ	SD-9363-KSVQ†

Featuring:

- Built-in Timer (0.8~30 seconds or toggle)
- Programmable LED (Red to Green or Green to Red)

The ENFORCER Outdoor Wave-to-Open Sensor is a full-featured exit plate which uses IR technology to allow egress from a protected area or activate a device with the simple wave of a hand. Since no touch is required, this sensor is suitable for use in hospitals, clinics, labs, cleanrooms (to reduce the risk of contamination), schools, factories, or offices.

*Weatherproof when installed properly (see page 3 for details)

†Spanish and French also available

SLI™ SECO-LARM®



ENFORCER® Wave-to-Open Sensor

Features:

- Adjustable sensor range up to 7" (18cm)
- Weather resistant for outdoor use (except models with mechanical override button)
- Stainless steel plate
- 1.2A relay, adjustable trigger duration 0.8~30 seconds or toggle
- LED illuminated sensor area for easy identification
- Selectable LED colors (turns from red to green or green to red) to show sensor activated

Overview:

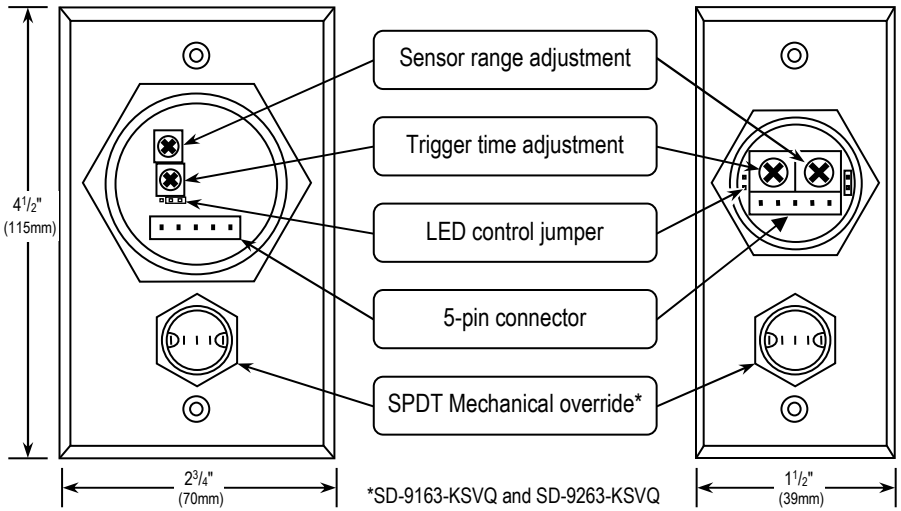

Specifications:

Power		12~24 VDC
Current drain (max.)	Standby	16mA@12VDC / 25mA@24VDC
	Triggered	25mA@12VDC / 32mA@24VDC
Relay type		SPDT dry contact, 1.2A@24VDC
Response time		10ms
LEDs	Standby	Red†
	Triggered	Green†
Output time		0.8~30 s, toggle
Range		2"~7" (5~18 cm)
IP rating		IP65‡
Temperature range		-4°~131° F (-20°~55° C)
Weight	Single Gang	108g
	Single Gang w/ Mechanical Override	125g
	Slimline	61g
	Slimline w/ Mechanical Override	77g
	European Plate	77g

SD-9263-KSVQ shown

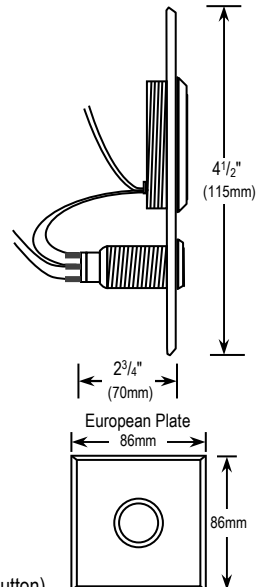

†Color function reversible ‡When properly installed (not including models with override button)

Wiring Diagram:

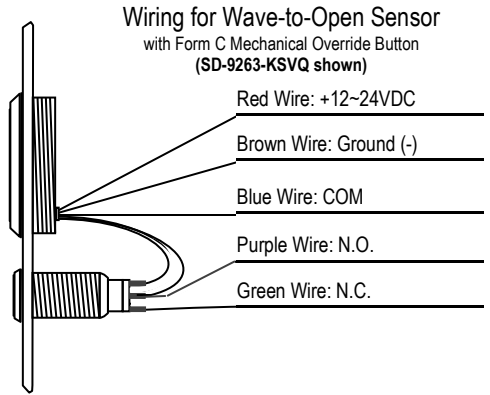
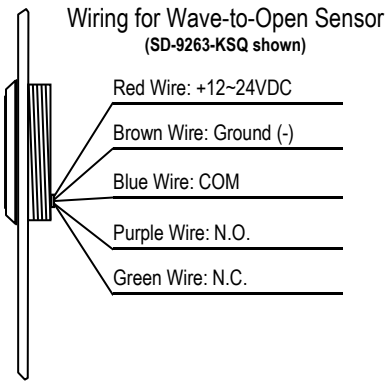

Installation:

1. Run four wires through the wall to a single-gang, slimline, or European back box.
2. Connect the four wires from the back box to the Request-to-Exit Sensor according to the **Wiring Diagram** above.
3. For weatherproof installation, use a waterproof back box and apply a bead of silicone sealant (not included) around the rim of the back box and faceplate edge. Apply a small amount of sealant below each screw head.
4. Screw the plate into the back box, taking care not to crimp the wires and ensuring a good seal.
5. Remove clear protective film from the sensor before use.

WARNING: Do not connect any device that will exceed 1.2A@24VDC.

Changing the LED Color Jumper Placement:

Slimline Models

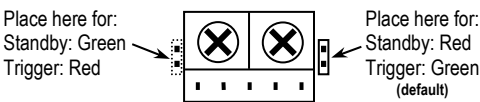

Single-Gang Models

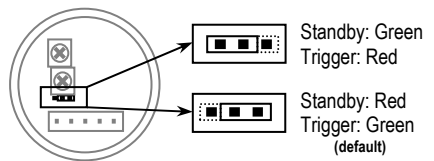

Adjusting the sensor range and trigger time:

1. The sensor range can be adjusted from 2"~7" (5~18 cm).
2. The trigger time can be adjusted from 0.8 to 30 seconds or toggle*.

NOTE: Do not force the adjustment trimpots to turn. Only minimal force is needed.



Trigger time: 0.8~30 seconds, toggle*

Default: 0.8 seconds

*Toggle: turn all the way clockwise



Sensor range: 2"~7" (5~18 cm)

Default: 7" (18cm)

*Set trigger time to maximum for toggle

Single-gang models

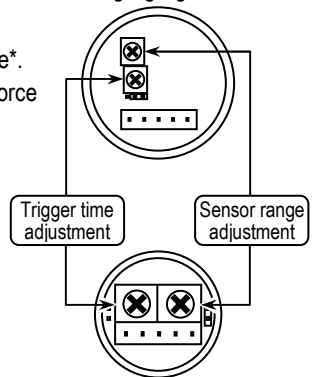

Slimline models

Sample Installation:

Typical installation with an electric lock:

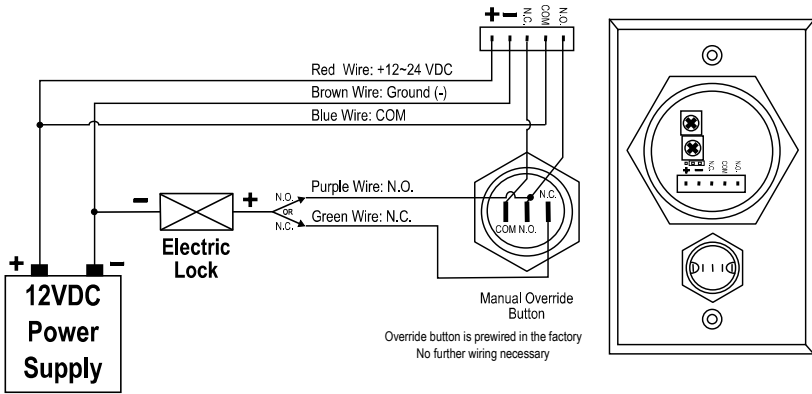

Care and Cleaning for the SD-9x63 Series Sensor:

The sensor requires special care to ensure reliability and a long operating life.

1. Use a soft, clean cloth for cleaning. Use the mildest type of cleaner available.
2. When cleaning, spray the cleaning solution onto the cleaning cloth instead of the unit.
3. Be sure to wipe off any excess liquid from the sensor. Wet spots may affect the sensor's performance.

IMPORTANT: Users and installers of this product are responsible for ensuring that the installation and configuration of this product complies with all national, state, and local laws and codes related to locking and egress devices. SECO-LARM will not be held responsible for the use of this product in violation of any current laws or codes.

IMPORTANT WARNING: For a weatherproof installation, ensure the unit is installed in a waterproof back box, and that the faceplate and faceplate screws are properly sealed. Incorrect mounting may lead to exposure to rain or moisture in the enclosure which could cause a dangerous electric shock, damage the device, and void the warranty. Users and installers of this product are responsible for ensuring this product is properly installed and sealed.

WARRANTY: This SECO-LARM product is warranted against defects in material and workmanship while used in normal service for one (1) year from the date of sale to the original customer. SECO-LARM's obligation is limited to the repair or replacement of any defective part if the unit is returned, transportation prepaid, to SECO-LARM. This Warranty is void if damage is caused by or attributed to acts of God, physical or electrical misuse or abuse, neglect, repair or alteration, improper or abnormal usage, or faulty installation, or if for any other reason SECO-LARM determines that such equipment is not operating properly as a result of causes other than defects in material and workmanship. The sole obligation of SECO-LARM and the purchaser's exclusive remedy, shall be limited to the replacement or repair only, at SECO-LARM's option. In no event shall SECO-LARM be liable for any special, collateral, incidental, or consequential personal or property damage of any kind to the purchaser or anyone else.

NOTICE: The SECO-LARM policy is one of continual development and improvement. For that reason, SECO-LARM reserves the right to change specifications without notice. SECO-LARM is also not responsible for misprints. All trademarks are the property of SECO-LARM U.S.A., Inc. or their respective owners. Copyright © 2020 SECO-LARM U.S.A., Inc. All rights reserved.

SECO-LARM® U.S.A., Inc.

16842 Millikan Avenue, Irvine, CA 92606
Phone: (949) 261-2999 | (800) 662-0800

Website: www.seco-larm.com
Email: sales@seco-larm.com

 **PITSW1**
Order Part# 763-171-8%
MI_SD-9x63-KSxQ_200713.docx